

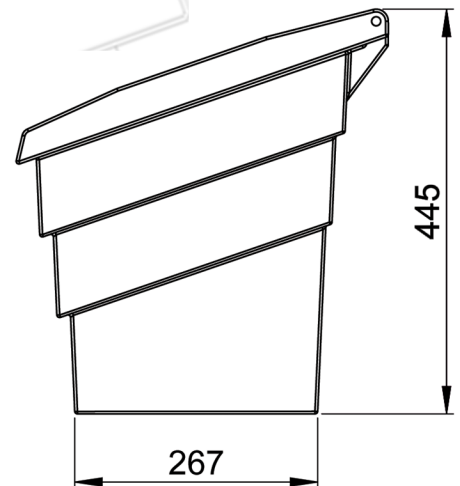

## Key facts

- Capacity: 50L approx.
- Weight: 5kg (unladen).
- Wall thickness: 4mm nominal.
- Basic dimensions: 590mm x 409mm x 445mm.
- Standard components: Lid & Body (assembled).
- Colours: various (refer to colour chart).
- Material: Medium Density Polyethylene.
- Cleaning instructions: only use warm soapy water.

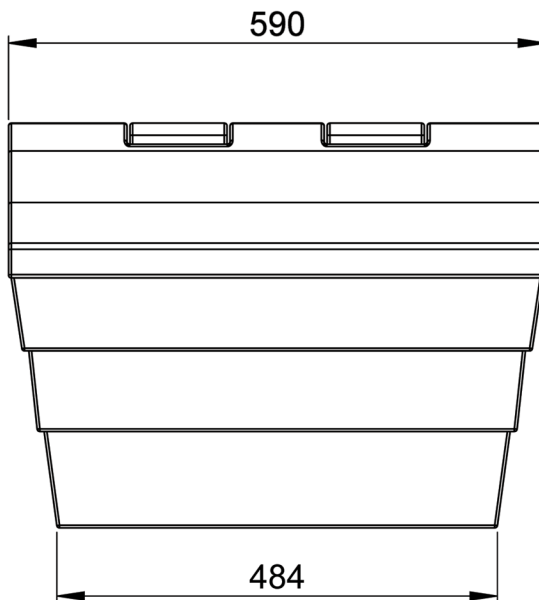
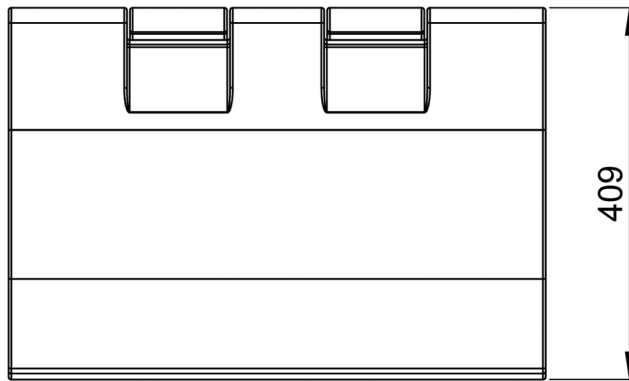

[www.impbins.com](http://www.impbins.com)